

Progressive Cavity Pumps

Standard design

The progressive cavity pump is a positive displacement pump with one single rotating shaft. A stainless steel rotor and a rubber stator are the main pumping components. The rotor is a circular section single screw. The rubber stator is vulcanized inside a steel pipe. Renowned for their versatility, different models are available in a choice of AISI 304, 316 stainless steel or in cast iron. Flow rates up to 130 m³/h, pressures up to 24 bar and temperatures up to 100 °C. Motorisation: direct motor, geared motor, variable speed motor, motor and pulley, gear motor with inverter.

MA series - Foodstuffs execution

Pumps for foodstuffs with a large suction chamber. Wetted parts are polished stainless steel with DIN threaded hygienic connections.

MI series - Industrial execution

Sturdy industrial pumps suitable for heavy duty requirements. Cast suction chamber and flanged connections.

MAN series

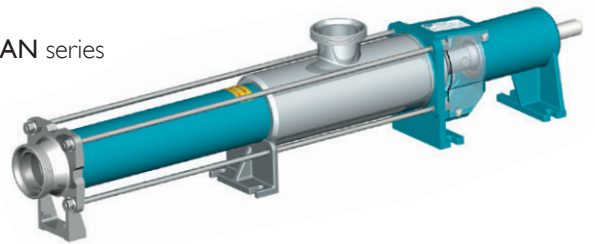

MIN series

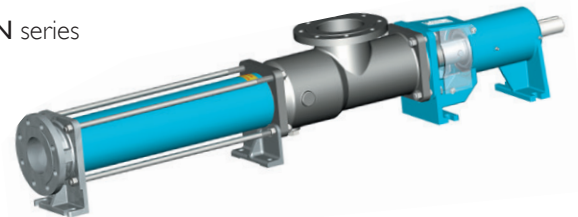

The progressive cavity pumps can handle almost any kind of fluid up to 800.000 cps., including abrasive liquids and suspensions with solids. The pumping action is delicate, without sudden pulsation and the flow rate is proportional to the rotational speed.

MC series - Features a hopper and a pre-feeding screw

Version with a hopper equipped with pre-feeding auger screw suitable for viscous products that do not flow easily through pipes. The top part is equipped with a rectangular flange to which any type of conveyance system can be connected.

MCR series - Features a hopper, a pre-feeding screw and a vane crusher

Version with hopper, pre-feeding screw and vane crusher, suitable for dense products in lumps, pieces or that tend to form a bridge around a normal screw feeder. The vane crusher is driven by an independent geared motor, to crush the product to be pumped, breaking down any large lumps and pushing them into the pre-feeding screw.

MCN series

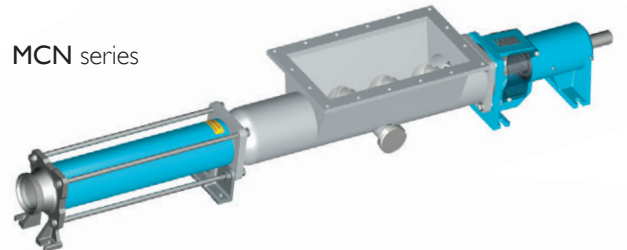

MCRN series

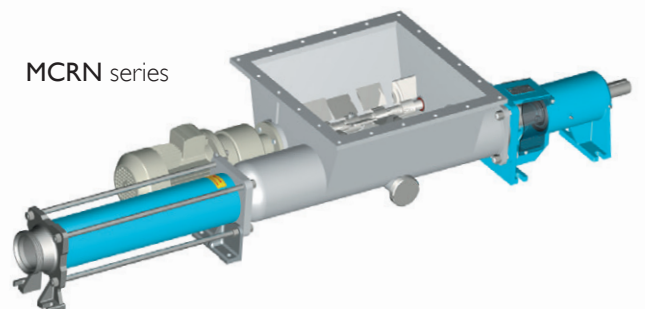

- MC2C series - Features an hopper and 2 pre-feeding screws
- MC2CR series - Features an hopper, 2 pre-feeding screws and 1 blade feeder

Version with hopper and double synchronised pre-feeding screws, mounted below a vane crusher. The vane crusher blades chop the product and push it towards the bottom of the hopper. The two pre-feeding screws then push the product into to the pump stator.

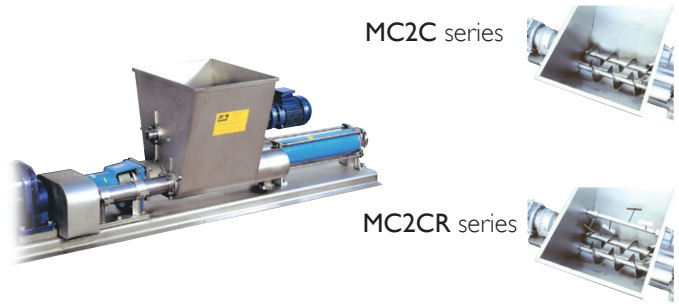

Blade feeders with 2 pre-feeding screws

Version with hopper and double synchronised pre-feeding screw operated by a reduction unit. It can be manufactured as a simple feeder or in combination with a lobe pump.

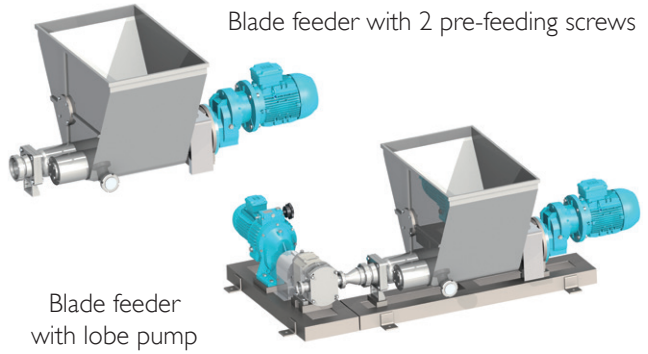

MAV series - Vertical execution

MAV Series pumps are intended for product transfer and drum or container emptying applications, in which the suction port is plunged directly into the product. As standard, MAV pumps have a suction to discharge port dimension of 1100 - 1400 mm. It can be mounted on a drum-holding trolley, with a choice of either a manual sliding or an alternative pneumatic lift and lower system.



Progressive cavity pump with crushing blades



The right solution designed for crushing products containing soft or fibrous components (fruit and vegetables). The great advantage of this device is to avoid the need for macerating equipment after the pump.

MOUNTING ARRANGEMENT

E VERSION

Close coupled with shaft directly coupled to the drive.

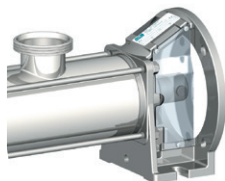

N VERSION

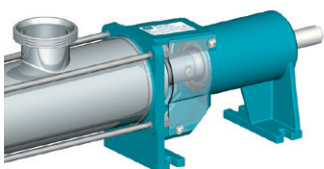

Double grease lubricated bearings for drive via a fl exible coupling.

STATOR MATERIALS

- GA - PERBUNAN (Black nitr. rubber)
- GB - EPDM
- GV - NEOPRENE rubber
- GD - FKM rubber Fluoroelastomer
- GE - HYPALON rubber
- GF - PERBUNAN (White nitr. rubber)
- GG - NATURAL rubber
- GI - SILICONE rubber
- GJ - HYDRO-TREATED NITR. rubber
- GL - SBR SCA972
- GM - EPDM (white rubber)
- GO - BUTYL

SEALS AVAILABLE

- Single internal mechanical seal
- Single external mechanical seal
- Double mechanical seal
- Double flushed mechanical seal
- Cooled packed gland seal

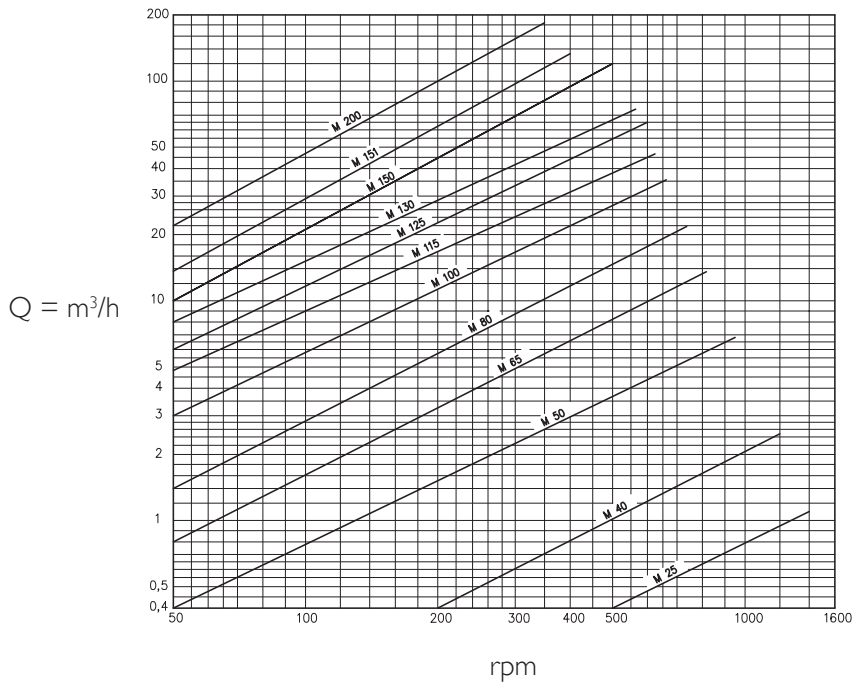

DIAGRAMS
1/2 lobe series

DIAGRAMS
2/3 lobe series

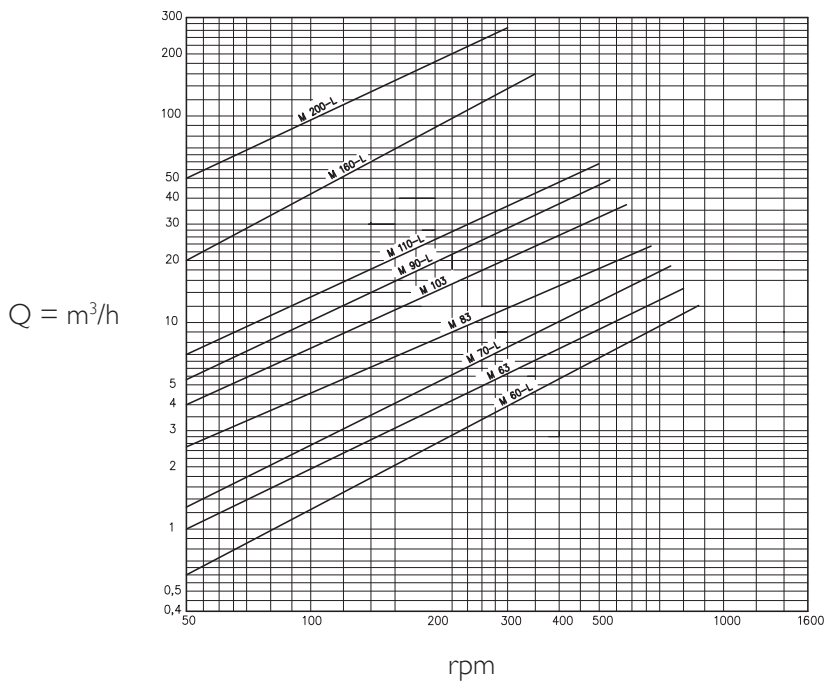
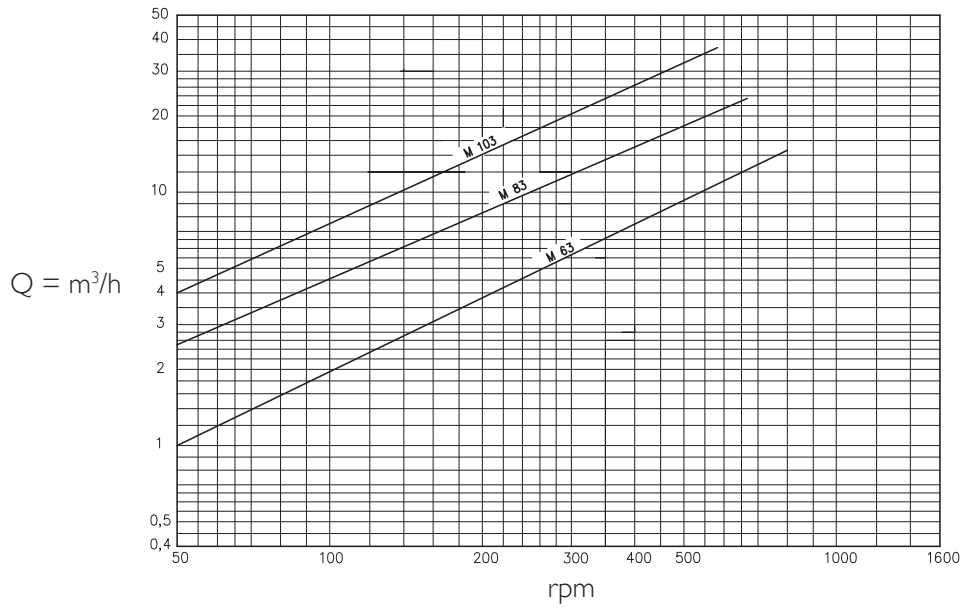

DIAGRAMS
long pitch series

The diagrams shows the theoretical flow rates at 0 pressure.

PROGRESSIVE CAVITY PUMPS FOR THE WINE INDUSTRY

PRESSING - TRANSFER OF PRESSED GRAPES,
MASH, MUSTS AND WINE

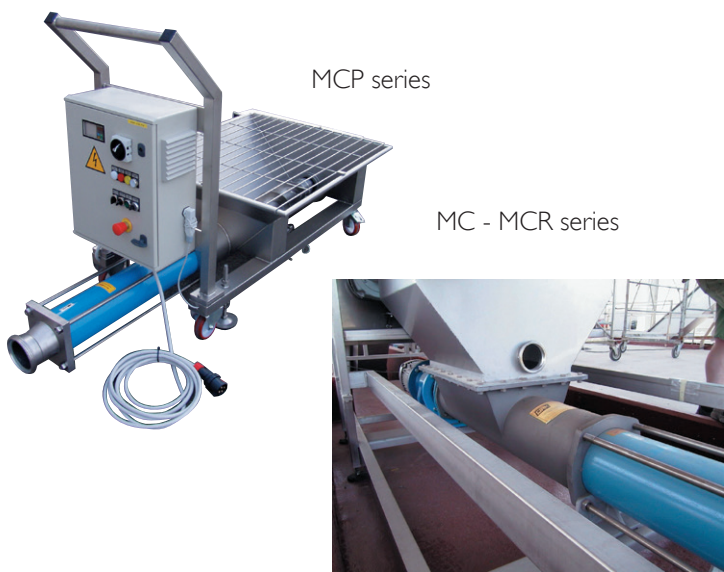

FILLING AND EMPTYING OF BARRELS



MAE series with electrical control panel for remote On/Off control from the stainless steel suction probes

RECIRCULATION - DECANTING



BOTTLING - FILTRATION - REFRIGERATION

MAE series

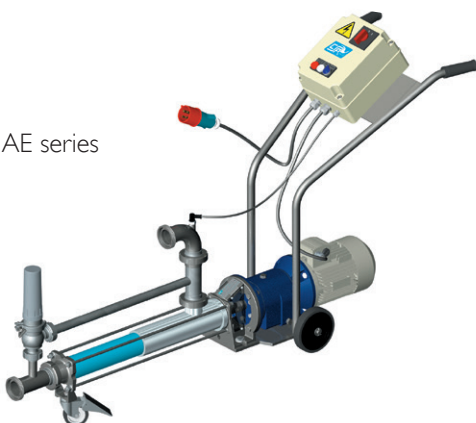

MAE series with electrical control panel enclosure



C.S.F. Inox S.p.A. Strada per Bibbiano, 7 - 42027 Montecchio E. (RE) - ITALY EU
Ph +39.0522.869911 r.a. - Fx +39.0522.865454 / 866758 - italia@csf.it - www.csf.it

Export Department • Commercial Étranger • Comercial Extranjero
Ph +39.0522.869922 - Fx +39.0522.869841 - export@csf.it - www.csf.it

All the instructions, data and representations (in whatever way executed) listed in this publication are indicative and do not binding. C.S.F. does not stand surety or undertake any obligation for the utilisation of this document and for the information contained. In particular, it does not guarantee against omissions or errors of the data and drawings here indicated.
Notice that the technical specifications, information and representations in this document are merely indicative and approximate. C.S.F. INOX reserves the right at any moment and without notice to modify the data, drawings and information indicated in this document.